

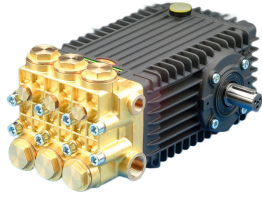

W3025



TECHNICAL INFORMATION

Flow (L/min)	25
Flow (US Gpm)	6,60
Rotation regime (rpm)	1450
Pressure (MPa)	30
Pressure (bar)	300
Pressure (psi)	4350
Power (hp)	20
Power (kW)	14,70
Overall dimensions L x l x h (mm)	340,5x242,5x189,5
Weight (kg)	18,5





Documents

Male shaft (key)

Double male shaft (key)

Male shaft (key) - vers. ATEX

Illustration Male shaft (key)

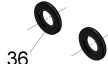
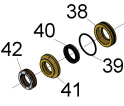
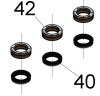
KIT 169	KIT 2	KIT 3	KIT 171	KIT 170
				

Lubrificare con grasso di vasellina
cod. 12.0021.00
**
Lubricate with vaseline grease
cod. 12.0021.00

Fissare con Loctite 542
colore ROSSO cod. 12.0062.00
*
Fix with red Loctite 542
cod. 12.0062.00

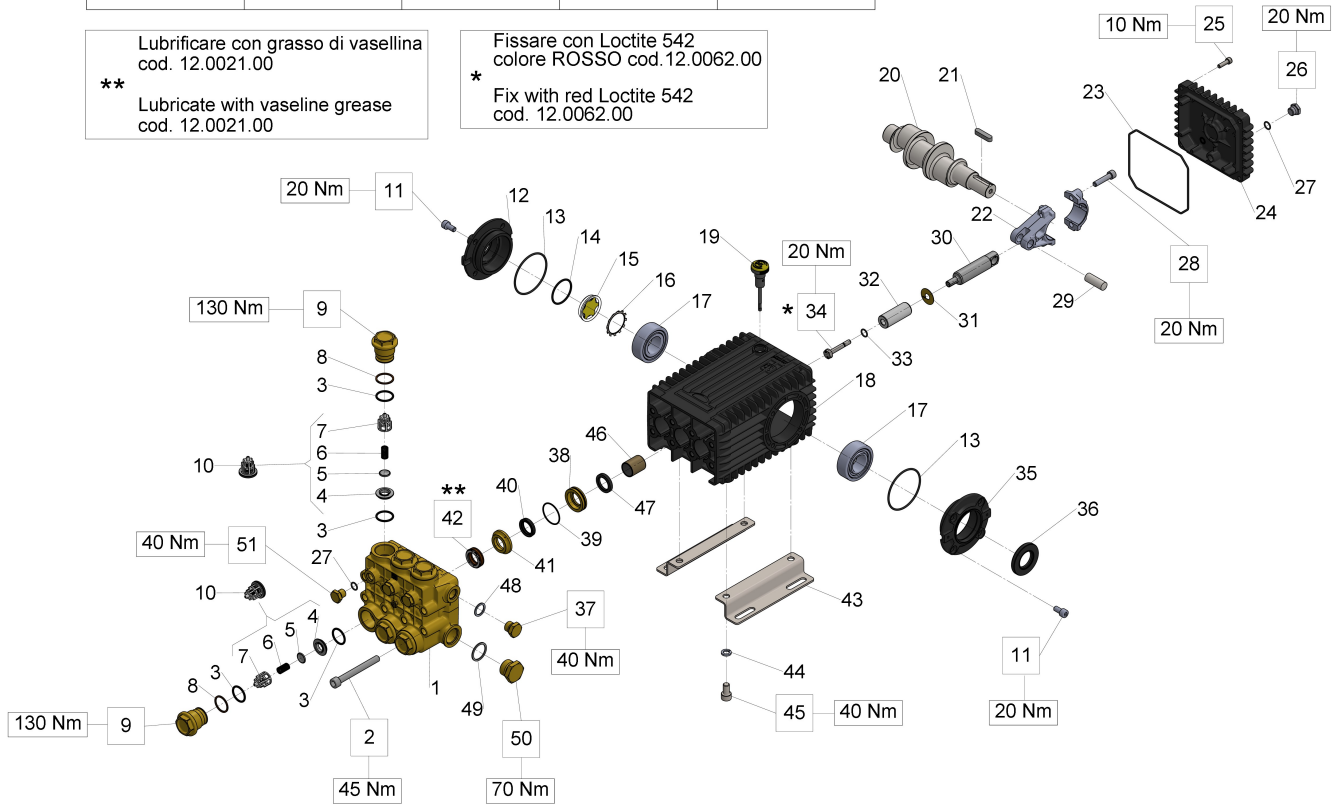



Illustration Male shaft (key)

Pos.	Code	Description	Qty	Notes
KIT3	34000301	KIT 3 OIL SEAL D.30X55X7	1	
KIT2	34000201	KIT 2 OIL SEAL D. 22X32X5,5	1	
KIT171	34017101	KIT 171 COMPL.SEAL D.20 (66)	1	
KIT170	34017001	KIT 170 PACKING D.20 (66)	1	
KIT169	34016901	KIT 169 INTAKE/DEL.VALVE (66)	1	
51	98204300	PLUG G1/4X10	3	
50	98226800	PLUG G3/4X16	1	
49	96770000	WASHER 26,5X32X1,5	1	
48	96738000	WASHER 17,5X23X1,5	1	
47	90162500	OIL SEAL 22x32x5	3	
46	90912600	BUSHING 22X25X30	3	
45	99364400	SCREW M 10x18-5931	4	
44	96710600	WASHER 10,2	4	
43	47200074	PUMP FOOT	2	
42	90269200	PACKING D.20X30X10 HP (66)	3	
41	66216070	INTERMEDIATE RING D.20	3	
40	90269000	PACKING D.20X28X6.5 LP (66)	3	
39	90361600	O-RING 34,65X1,78 (2137)	3	
38	66080070	PACKING RETAINER D. 20	3	
37	98210000	PLUG G3/8X13	1	
36	90164800	OIL SEAL 30x55x7	1	
35	47151022	OPEN SIDE COVER (47-66)	1	
34	66219566	PISTON BOLT	3	
33	90358400	O-RING D.10,82X1,78(2043)90SH3		
32	66040009	PISTON D. 20X54	3	
31	96710100	WASHER D. 10X28X0.5	3	
30	66050066	PISTON GUIDE - S.S.	3	
29	97740500	CONNECTING ROD-PIN D.14X39	3	
28	99309900	SCREW M 8x35 UNI 5931	6	
27	90358500	O-RING 10,82X1,78 (2043)	4	
26	98204250	PLUG G1/4"x12	1	
25	99188400	SCREW M 6x20 UNI 5931	4	
24	66160022	REAR COVER	1	
23	90392200	O-RING D.133.02X 2,62(3525)	1	
22	66030001	CONNECTING ROD	3	
21	91489200	KEY 8(h9)X7X35 UNI 6604/A	1	

Illustration Male shaft (key)

Pos.	Code	Description	Qty	Notes
20	66020035	CRANKSHAFT C.19 - D. 24	1	
19	98210600	OIL DIP-STICK G3/8X80	1	
18	66010022	CRANKCASE	1	
17	91838000	ROLLER BEARING NJ2206EC	2	
16	90075600	CIRCLIP D.45 (Z145)	1	
15	70211801	OIL SIGHT GLASS	1	
14	90387700	O-RING 39,34X2,62 (3156)	1	
13	90391300	O-RING 67,95X2,62 (3268)	2	
12	47151222	SIDE CRANKCASE COVER FOR OIL GAUGE	1	
11	99303900	SCREW M 8x16 UNI 5931	8	
10	36712701	INTAKE/DEL.VALVE ASSY(66)	6	
9	66130041	VALVE CAP M32x1.5x29.5	6	
8	90516500	ANTI-EXTR.RING D.24.7x29x1.5	6	
7	36203551	VALVE CAGE	6	
6	94738800	SPRING Dm. 10x18.5	6	
5	36203476	SPHERICAL VALVE	6	
4	36203366	VALVE SEAT	6	
3	90385700	O-RING 23,81X2,62 (132)	12	
2	99380100	SCREW M10X90 UNI 5931 8.8	8	
1	66120041	PUMP HEAD (PISTON D.20)	1	

Illustration Double male shaft (key)

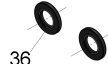
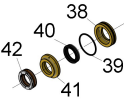
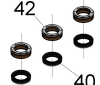
KIT 169	KIT 2	KIT 3	KIT 171	KIT 170
				

Lubrificare con grasso di vasellina
cod. 12.0021.00
**
Lubricate with vaseline grease
cod. 12.0021.00

Fissare con Loctite 542
colore ROSSO cod. 12.0062.00
*
Fix with red Loctite 542
cod. 12.0062.00

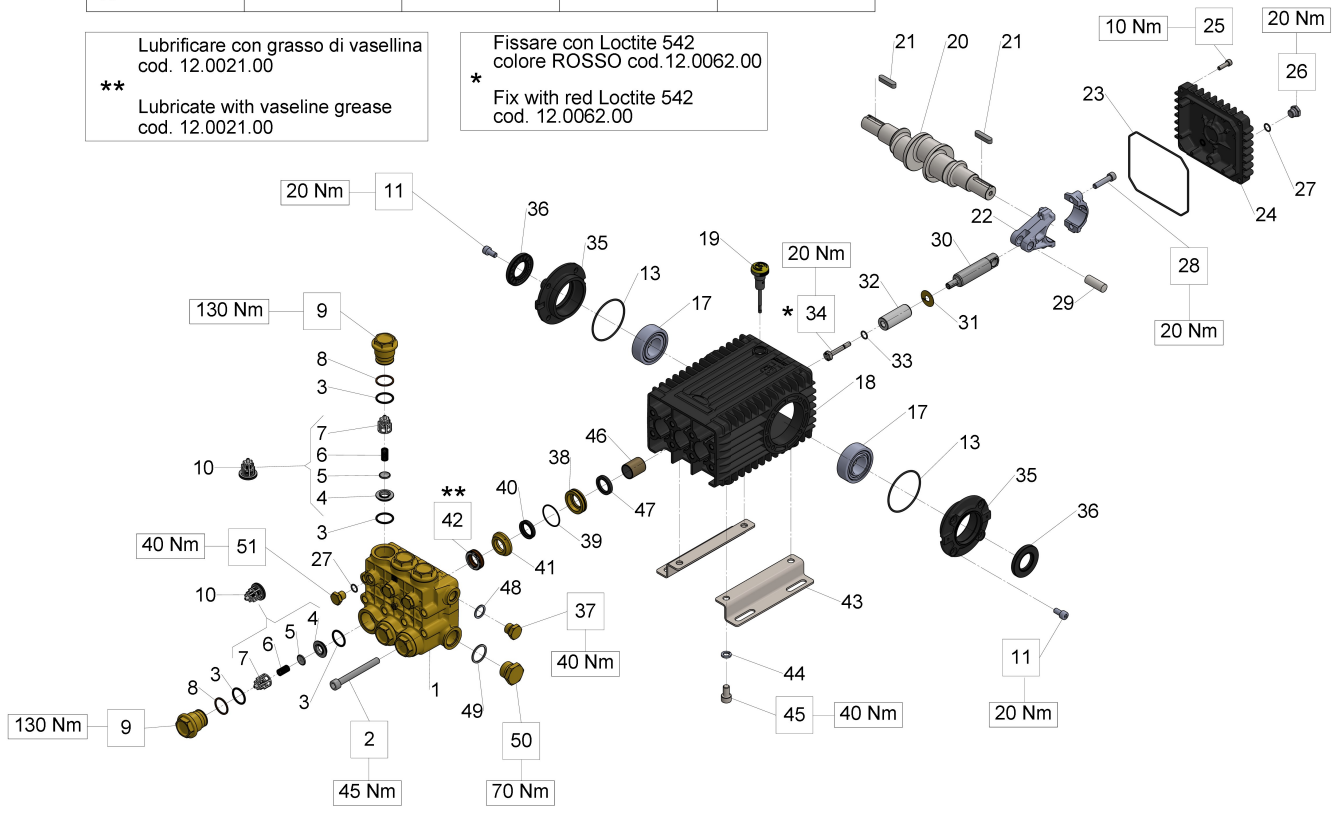

Illustration Double male shaft (key)

Pos.	Code	Description	Qty	Notes
KIT3	34000301	KIT 3 OIL SEAL D.30X55X7	1	
KIT2	34000201	KIT 2 OIL SEAL D. 22X32X5,5	1	
KIT171	34017101	KIT 171 COMPL.SEAL D.20 (66)	1	
KIT170	34017001	KIT 170 PACKING D.20 (66)	1	
KIT169	34016901	KIT 169 INTAKE/DEL.VALVE (66)	1	
51	98204300	PLUG G1/4X10	3	
50	98226800	PLUG G3/4X16	1	
49	96770000	WASHER 26,5X32X1,5	1	
48	96738000	WASHER 17,5X23X1,5	1	
47	90162500	OIL SEAL 22x32x5	3	
46	90912600	BUSHING 22X25X30	3	
45	99364400	SCREW M 10x18-5931	4	
44	96710600	WASHER 10,2	4	
43	47200074	PUMP FOOT	2	
42	90269200	PACKING D.20X30X10 HP (66)	3	
41	66216070	INTERMEDIATE RING D.20	3	
40	90269000	PACKING D.20X28X6.5 LP (66)	3	
39	90361600	O-RING 34,65X1,78 (2137)	3	
38	66080070	PACKING RETAINER D. 20	3	
37	98210000	PLUG G3/8X13	1	
36	90164800	OIL SEAL 30x55x7	2	
35	47151022	OPEN SIDE COVER (47-66)	2	
34	66219566	PISTON BOLT	3	
33	90358400	O-RING D.10,82X1,78(2043)90SH3		
32	66040009	PISTON D. 20X54	3	
31	96710100	WASHER D. 10X28X0.5	3	
30	66050066	PISTON GUIDE - S.S.	3	
29	97740500	CONNECTING ROD-PIN D.14X39	3	
28	99309900	SCREW M 8x35 UNI 5931	6	
27	90358500	O-RING 10,82X1,78 (2043)	4	
26	98204250	PLUG G1/4"x12	1	
25	99188400	SCREW M 6x20 UNI 5931	4	
24	66160022	REAR COVER	1	
23	90392200	O-RING D.133.02X 2,62(3525)	1	
22	66030001	CONNECTING ROD	3	
21	91489200	KEY 8(h9)X7X35 UNI 6604/A	2	

Illustration Double male shaft (key)

Pos.	Code	Description	Qty	Notes
20	66021035	CRANKSHAFT C.19 - DUAL PTO	1	
19	98210600	OIL DIP-STICK G3/8X80	1	
18	66010022	CRANKCASE	1	
17	91838000	ROLLER BEARING NJ2206EC	2	
13	90391300	O-RING 67,95X2,62 (3268)	2	
11	99303900	SCREW M 8x16 UNI 5931	8	
10	36712701	INTAKE/DEL.VALVE ASSY(66)	6	
9	66130041	VALVE CAP M32x1.5x29.5	6	
8	90516500	ANTI-EXTR.RING D.24.7x29x1.5	6	
7	36203551	VALVE CAGE	6	
6	94738800	SPRING Dm. 10x18.5	6	
5	36203476	SPHERICAL VALVE	6	
4	36203366	VALVE SEAT	6	
3	90385700	O-RING 23,81X2,62 (132)	12	
2	99380100	SCREW M10X90 UNI 5931 8.8	8	
1	66120041	PUMP HEAD (PISTON D.20)	1	

Illustration Male shaft (key) - vers. ATEX

KIT 169	KIT 2	KIT 3	KIT 171	KIT 170

Lubrificare con grasso di vasellina
cod. 12.0021.00
**
Lubricate with vaseline grease
cod. 12.0021.00

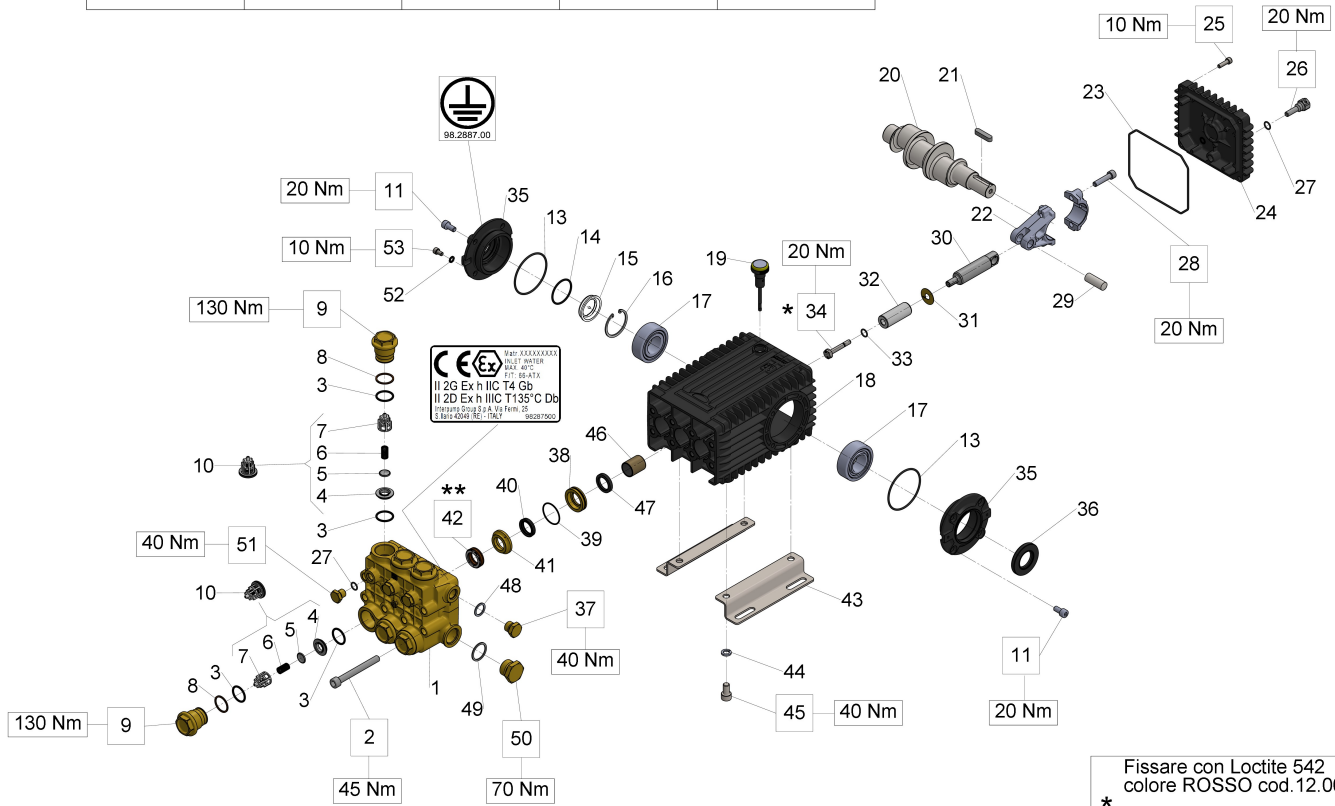

Fissare con Loctite 542
colore ROSSO cod.12.0062.00
*
Fix with red Loctite 542
cod. 12.0062.00

Illustration Male shaft (key) - vers. ATEX

Pos.	Code	Description	Qty	Notes
KIT3	34000301	KIT 3 OIL SEAL D.30X55X7	1	
KIT2	34000201	KIT 2 OIL SEAL D. 22X32X5,5	1	
KIT171	34017101	KIT 171 COMPL.SEAL D.20 (66)	1	
KIT170	34017001	KIT 170 PACKING D.20 (66)	1	
KIT169	34016901	KIT 169 INTAKE/DEL.VALVE (66)	1	
53	99180900	SCREW M06X10 5931 A2-70	1	
52	96693950	WASHER 6.4x11.0x0.7 D6798A INOX	1	
51	98204300	PLUG G1/4X10	3	
50	98226800	PLUG G3/4X16	1	
49	96770000	WASHER 26,5X32X1,5	1	
48	96738000	WASHER 17,5X23X1,5	1	
47	90162500	OIL SEAL 22x32x5	3	
46	90912600	BUSHING 22X25X30	3	
45	99364400	SCREW M 10x18-5931	4	
44	96710600	WASHER 10,2	4	
43	47200074	PUMP FOOT	2	
42	90269200	PACKING D.20X30X10 HP (66)	3	
41	66216070	INTERMEDIATE RING D.20	3	
40	90269000	PACKING D.20X28X6.5 LP (66)	3	
39	90361600	O-RING 34,65X1,78 (2137)	3	
38	66080070	PACKING RETAINER D. 20	3	
37	98210000	PLUG G3/8X13	1	
36	90164800	OIL SEAL 30x55x7	1	
35	47151322	SIDE CRANKCASE COVER (ATEX)	1	
35	47151022	OPEN SIDE COVER (47-66)	1	
34	66219566	PISTON BOLT	3	
33	90358400	O-RING D.10,82X1,78(2043)90SH3		
32	66040009	PISTON D. 20X54	3	
31	96710100	WASHER D. 10X28X0.5	3	
30	66050066	PISTON GUIDE - S.S.	3	
29	97740500	CONNECTING ROD-PIN D.14X39	3	
28	99309900	SCREW M 8x35 UNI 5931	6	
27	90358500	O-RING 10,82X1,78 (2043)	4	
26	98203600	PLUG G1/4x8 FOR PROBE D.6 S.S.	1	

Illustration Male shaft (key) - vers. ATEX

Pos.	Code	Description	Qty	Notes
25	99188400	SCREW M 6x20 UNI 5931	4	
24	66160022	REAR COVER	1	
23	90392200	O-RING D.133.02X 2,62(3525)	1	
22	66030001	CONNECTING ROD	3	
21	91489200	KEY 8(h9)X7X35 UNI 6604/A	1	
20	66020035	CRANKSHAFT C.19 - D. 24	1	
19	98210700	OIL DIPSTICK G3/8X64 D4+FILTER ATEX	1	
18	66010022	CRANKCASE	1	
17	91838000	ROLLER BEARING NJ2206EC	2	
16	90075500	STOP RING J45 UNI7437	1	
15	70211751		1	
14	90387700	O-RING 39,34X2,62 (3156)	1	
13	90391300	O-RING 67,95X2,62 (3268)	2	
11	99303900	SCREW M 8x16 UNI 5931	8	
10	36712701	INTAKE/DEL.VALVE ASSY(66)	6	
9	66130041	VALVE CAP M32x1.5x29.5	6	
8	90516500	ANTI-EXTR.RING D.24.7x29x1.5	6	
7	36203551	VALVE CAGE	6	
6	94738800	SPRING Dm. 10x18.5	6	
5	36203476	SPHERICAL VALVE	6	
4	36203366	VALVE SEAT	6	
3	90385700	O-RING 23,81X2,62 (132)	12	
2	99380100	SCREW M10X90 UNI 5931 8.8	8	
1	66120041	PUMP HEAD (PISTON D.20)	1	