

## **EUROFLAT SERIES TYPES CM.. SM.. MM..**

**AUTOMATIC GAS BURNER CONTROL  
SYSTEMS FOR GAS BURNERS AND GAS  
BURNING APPLIANCES WITH OR  
WITHOUT FAN**

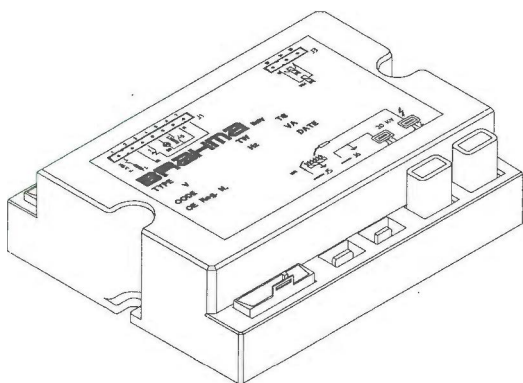

### **Application**

This range of electronic gas burner control systems has been designed specifically for atmospheric and fan assisted burners for intermittent operation (systems for non-permanent operation).

All these controls are provided with non-volatile lock-out, which means that a restart from the safety shut-down condition can only be accomplished by a manual reset of the system.

The automatic burner control units of this series are suitable for:

- combi boilers
- heating boilers
- warm air generators
- radiant heaters
- water heaters

Due to the design and the variety of models they can be used also for the automation of ovens, cookers and in general in gas firing installations with atmospheric burner.

### **Features**

Table 1 shows the main features of this series. Other important features are:

- EC - Type certification (CE Reg. N° 63AQ0625) in accordance with Gas Appliance Directives 90/396 and 93/68;
- in accordance with EN298 (European standard for automatic gas burner control systems);
- flame monitoring by the rectification property of the flame: ionization;
- two independent safety contacts in series on the gas valve output;
- electrical service life at max. loading >250.000 operations;
- inbuilt ignition device completely of solid state design and high efficiency;
- auxiliary contact for low power ignition or main gas valve control for intermittent pilot systems (this contact is not isolated from the main supply voltage by reinforced isolation, therefore the relay contact is not suitable to supply SELV circuits - Safety Extra Low Voltage, e.g.24V);

TABLE 1

	BURNER				OPTIONS		classification code according to EN298 (2)
	single flame	dual flame	atmospheric without fan	atmospheric with fan	auxiliary contact (1)	single electrode	
CM 11	*		*				AMCLXN
CM 31	*			*			FMCLXN
CM 32		*		*	*		FMCLXN
SM 11		*	*		*		AMCLXN
MM 51		*	*		*	*	AMCLXN
MM 32		*		*	*	*	FMCLXN

(1) : This contact is not isolated from the main supply voltage by reinforced isolation, therefore the relay contact is not suitable to supply SELV circuits - Safety Extra Low Voltage, e.g. 24V.

(2) : Flame failure during TS causes spark restoration

#### TECHNICAL DATA

**Supply Voltage:** 230V-50/60Hz  
on request: 110/120V-50/60Hz

**Operating temperature range:** -20°C +60°C

**Ambient humidity:** 95% max at 40°C

**Protection degree:** IP 00

#### Times:

- Pre-purge or waiting time (TW): 1,5/3/5/10/20/30/40 s

- Safety time (TS): 3/5/8/10/20/30/40/50/60 s

- Drop out time on running flame failure: < 1 s

The times given on the burner control label correspond to the values guaranteed. The actual values differ slightly from the values given, pre-purge and waiting times are in fact longer and safety time shorter than their nominal values.

#### Power consumption, at starting up:

atmospheric burner 10 VA

atmospheric fan-assisted burner 12 VA

#### Power consumption, running:

atmospheric burner 7 VA

atmospheric fan-assisted burner 9 VA

#### Contact rating:

I max

-Thermostat: 4 A  $\cos \varphi = 0.4$

-VG1: 0.5 A  $\cos \varphi = 0.4$

-VG2: 0.5 A  $\cos \varphi = 0.4$

-Fan: 1 A  $\cos \varphi = 0.4$

-Alarm: 0.5 A  $\cos \varphi = 1$

-Auxiliary contact: 0.5 A  $\cos \varphi = 0.4$

#### Max. length of the cables of external components:

1 m

**Fuse rating internal:** 4 A Fast

**Fuse rating external:** 3.15 A Fast

#### Flame control:

The ionization flame detector device makes use of the rectification property of the flame.

The ionization flame detector device is not a safe to touch output (no provision with protective impedances).

-Minimum ionization current: 1.2 $\mu$ A  
on request: 0.5 $\mu$ A

-Recommended ionization current: 3 ÷ 5 times the minimum ionization current

-Max length of the cable: 1 m

-Minimum insulation resistance of cable and flame detector device to earth:  $\geq 50M\Omega$

-Max. parasitic capacitance of detection probe:  $\leq 1nF$

-Max. short circuit current: < 200 $\mu$ A AC

#### Ignition:

-Ignition voltage: 20 KV at 30pF loading

-Repetition rate: 25 Hz

-Max.length of the cable: 2 m

-Spark gap recommended: 2-4 mm

-Consumption: 2,5 VA

-Spark energy: 15 mJ

**Weight:** 200 g

#### Controls for special applications:

On request it is possible to meet special requirements concerning times, repetition rate of the sparks, minimum ionization current and operating cycle.

#### CONSTRUCTION

The enclosure made of plastic material protects the control from mechanical damage, dust and dirt from the conditions of installation.

The printed circuit board dimensions have been reduced by means of a module with surface mounted components. A varistor protects the control from voltage transients on the mains supply. An internal fuse protects the relays of the control box in case of short circuits on the outputs (valves, fan and lock-out signal). This is not an accessible fuse and the control must be protected with a fuse of the fast blow type suitable to the load connected and never exceeding 3.15A.

#### Overall Dimensions

The control units of the EUROFLAT series can be supplied with different executions but with the same enclosure. The following figure (Fig. 1) shows the overall dimensions of the controls.

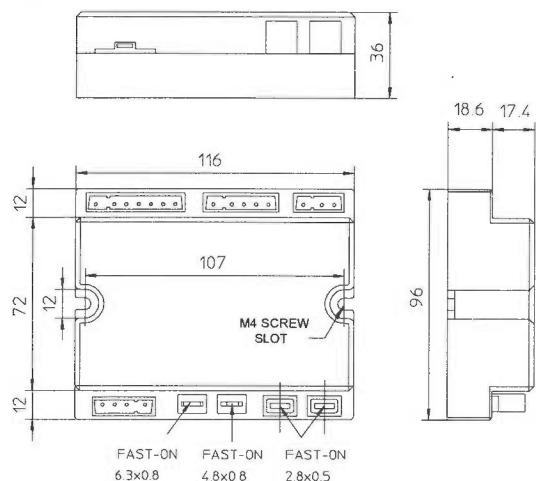

Fig.1

#### Accessories

The control units are usually supplied with a kit of female connectors and/or reset button. Do not fit terminals and female connectors of different types.

These accessories can be supplied upon request (see Fig.2).

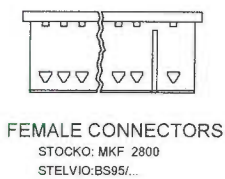
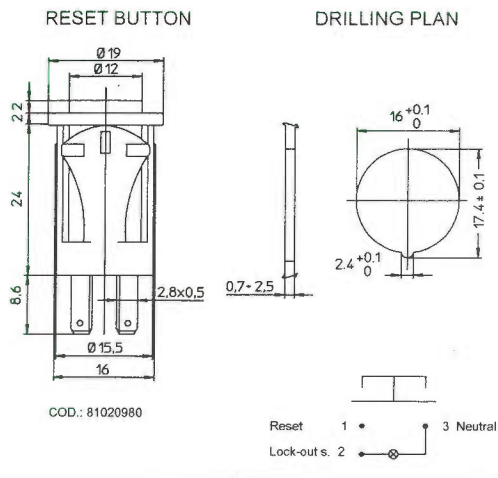

Fig.2

### Connection

Using non reversible connectors with different number of poles makes the connection easy and reliable. One way fast-on connectors of different sizes for ignition and detection electrodes permit their easy installation and replacement.

The dual output ignition device allows spark generation on one point (a), two points (b) or between two electrodes isolated from the metal frame of the burner (c), see Fig.3.

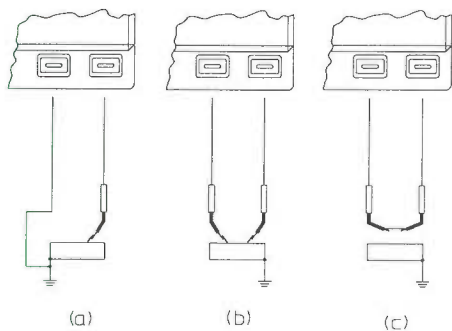

Fig.3

Regarding the connection of the control units, provisions such as strain reliefs, sufficient earth terminals and neutral terminals should be present in the appliance or in external connection boxes.

### DIRECTIONS FOR THE USE

- For technical-safety reasons a regulation shutdown must occur every 24 hours (systems for non-permanent operation).
- Automatic controls are safety devices and shall not be opened. Responsibility and guarantee of the manufacturer is invalidated if the control is opened.
- The control must be connected and disconnected only without the main power.
- The control can be mounted in any position.

- Avoid exposure of the control unit to dripping water.
- Ventilation and the lowest temperature ensures the longest life of the control.
- Make sure that the type (code and times) you are using is correct before installing or replacing the control.
- The gas appliance in which the control is installed must provide adequate protection against the risk of electrical shock (at least IP20).

### Electrical installation

- The applicable national regulation and European standards (e.g. EN60335-1/prEN50165) regarding electrical safety must be respected.
- Live and neutral should be connected correctly, a mistake could cause a dangerous situation, i.e. the valves would still be live with the thermostats and limits switched off. Besides, if live-neutral polarity is not respected the control performs a non-volatile lock-out at the end of the safety time at starting up.
- Before starting check the cables carefully. Wrong connections can damage the control and compromise the safety.
- Take great care while connecting the lock-out signal and reset button: an inversion in the connection can damage the control.
- The earth terminal of the control, the metal frame of the burner and the earth on the mains supply must be well connected.
- Avoid putting the detection cable close to power or ignition cables.
- Use a heat resistant cable for the detection probe, well insulated to ground and protected from possible moisture (or water in general).
- Use an ignition cable as short and straight as possible and keep it far from other conductors to reduce the emission of electromagnetic interference (max.length <2m and insulation voltage >25KV).

In case of live-neutral network with unearthed neutral or live-live network (with centre of the star not earthed) the control can operate correctly by means of a built-in resistor. **IMPORTANT: in the event of "partial" short circuits or bad insulation between phase(s) and earth the voltage on the ionization probe can be reduced until it causes the lock-out of the control. In the presence of this kind of network it is advisable to use our isolation transformer type AR1.**

### Checking at start

Always check the control before the first start and also after substitutions or a long period of non operation of the system. Before any ignition attempt make sure that the combustion chamber is free from gas.

Then make sure that:

- if the attempt to start occurs without the gas supply the control performs a non-volatile lock-out after TS;
- when stopping the gas flow (while the control is in running state) supply to the gas valve is interrupted within 1 second and after a recycling, the control proceeds to a non-volatile lock-out;
- operating times and sequence are suitable;
- the level of the flame signal is sufficient, see Fig.4 for the measuring test;
- the ignition probe(s) is (are) adjusted in the most stable way for a spark gap between 2-4 mm;

- the intervention of limiters or safety devices causes a safety shut-down according to the application.

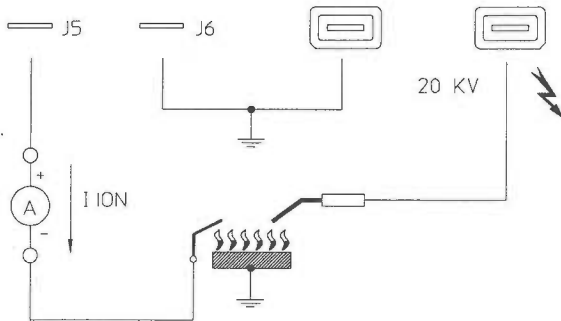

Fig.4

### Operation

At every start the control unit proceeds to a self-checking of its own components. During the pre-purge or waiting time the internal circuit makes a test of the flame signal amplifier circuit. A parasitic flame signal or fault in the amplifier prevents the control from starting.

In the types with control of the fan, before the elapsing of pre-purge time, the air pressure switch contacts are checked to prove their "no air flow" state.

Only if the test is positive the fan is started and with the air pressure switch in "air flow" state, pre-purge time begins.

At the end of the waiting or pre-purge times the gas valve is energized and the ignition device is operated. If a flame is detected during the safety time the ignition device is inhibited and, in the suitable models, the independent auxiliary contact will switch from off to flame detected position or the second gas valve will be energized.

On the contrary, if the control doesn't detect a flame by the end of TS, it proceeds to non-volatile lock-out, the gas valve and the ignition device are switched off while the lock-out signal output is supplied.

When the flame fails during the safety time, then the ignition device is activated within one second.

The attached diagrams are useful to understand how each control operates.

### Reset of the control

When a control has gone to non-volatile lockout, an interval of 3 seconds should be allowed before attempting to reset the control unit; if this time is not observed then the control may not reset correctly.

**BRAHMA**

BRAHMA SpA  
Via del Pontiere,31  
37045 Legnago (Vr)  
Tel.(0442)635211 - Telefax (0442) 25683

# CONNECTION DIAGRAMS

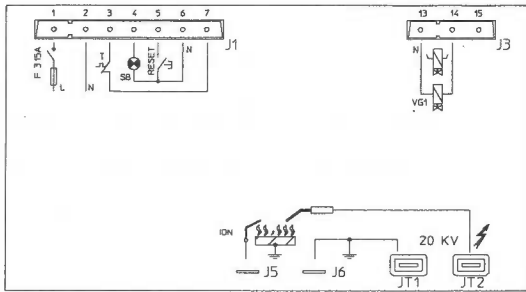

TYPE CM11

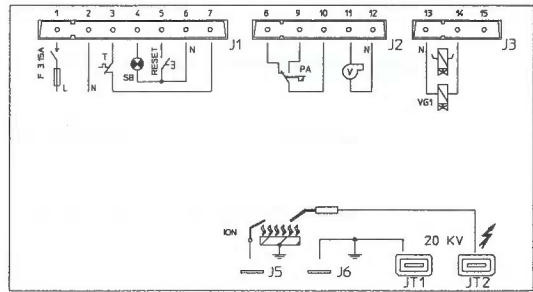

TYPE CM31

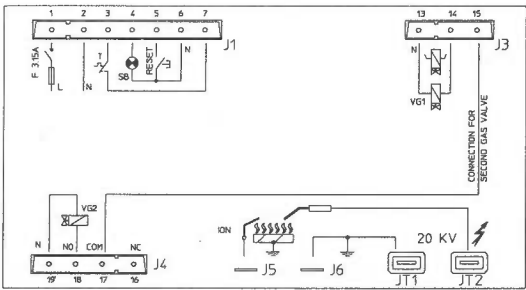

TYPE SM11

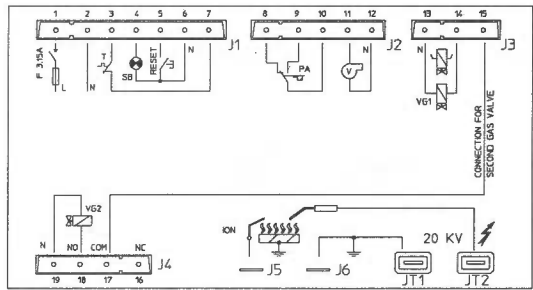

TYPE CM32

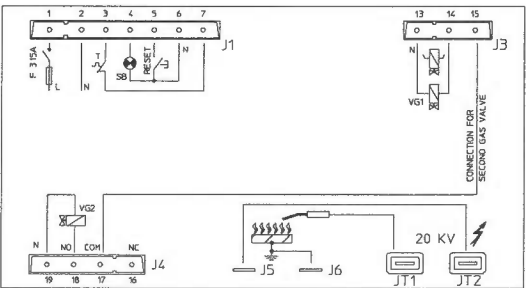

TYPE MM51

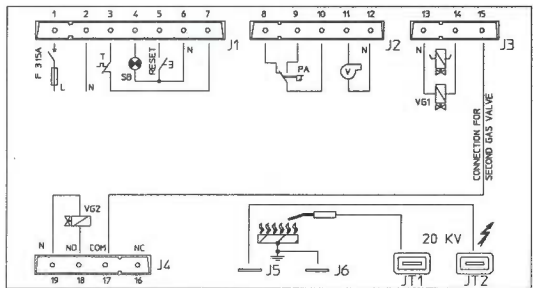

TYPE MM32



THERMOSTAT



FAN



AIR PRESSURE  
SWITCH



FUSE



BURNER



LOCK-OUT  
SIGNAL



FIRST GAS  
VALVE



SECOND GAS  
VALVE

**NOTE:** the limit thermostat has to be wired in series to the live.

# OPERATING CYCLES

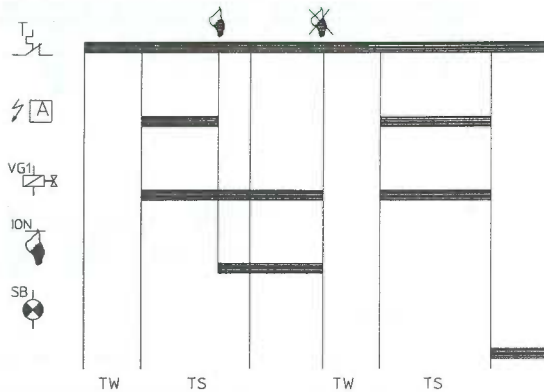

TYPE CM11

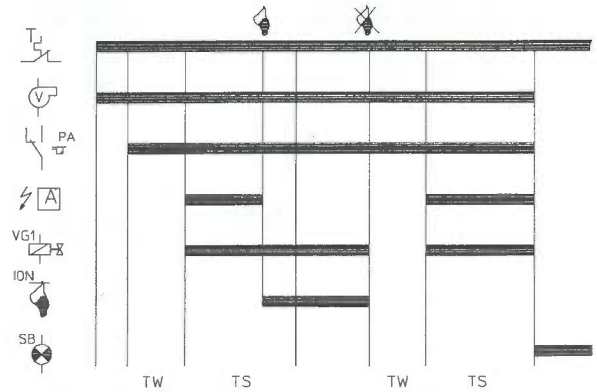

TYPE CM31

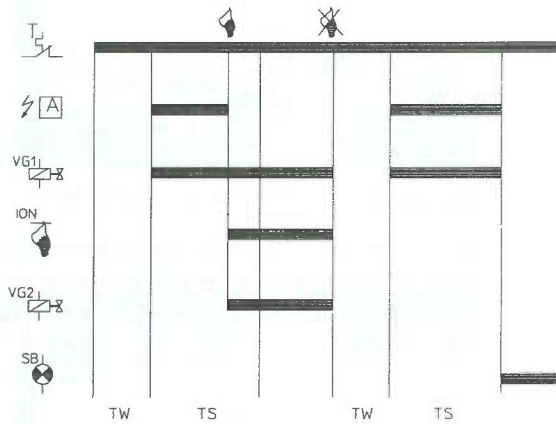

TYPE SM11 MM51

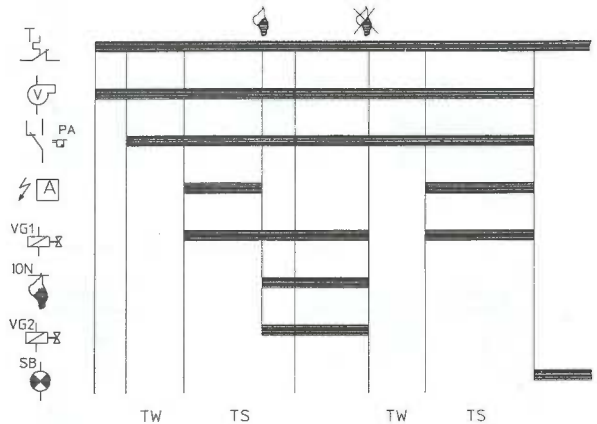

TYPE CM32 MM32



**Euroflat Series**  
**Types CM.. SM.. MM..**