

TRG

30

2 POLES | 2 POLI

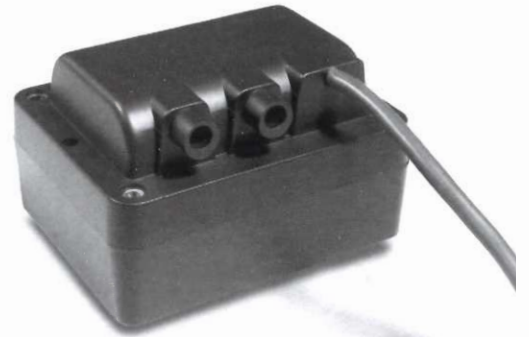
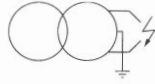

Technical drawing | Disegno tecnico [mm]

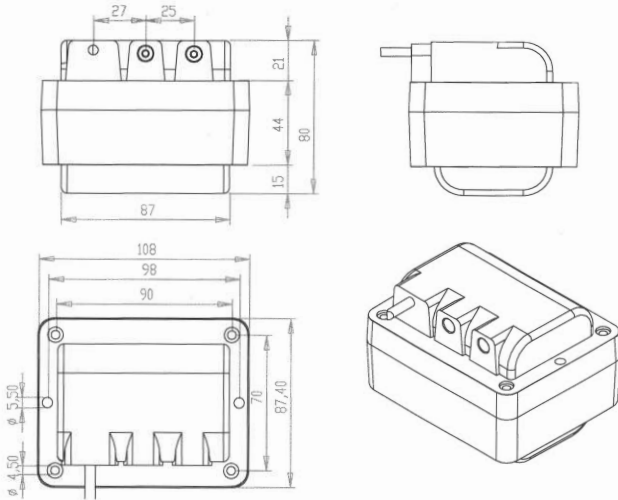

Inlet | Ingressi

Standard buried cable
Cavo annegato standard

COFI plug
Presa per spina Cofi

Triangle plug
Presa spina Triangolo

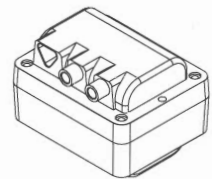
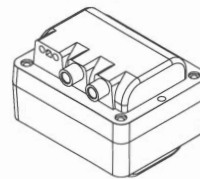
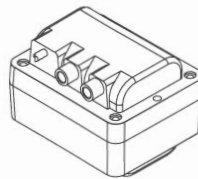

Outlet | Uscite

Cod: SP

Cod: VIMAN

Cod: SPRAS

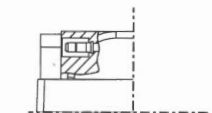
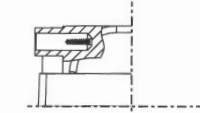
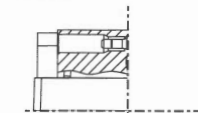

Cod: SPMAN

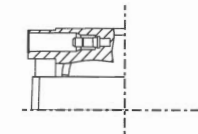

Type	Vin	Freq	Vout	Iout	ED	Output	Note
------	-----	------	------	------	----	--------	------

CONTINUOUS 100% | CONTINUI 100%

TRG1015C	230V	50Hz	2x5 kV	15 mA	100%	Grounded center	Ⓢ CE
TRG1020C	230V	50Hz	2x5 kV	20 mA	100%	Grounded center	Ⓢ CE

INTERMITTENT | INTERMITTENTI

TRG1035	230V	50Hz	2x5 kV	35 mA	25% on 4'	Grounded center	Ⓢ CE
TRG1035 US	120V	60Hz	2x5 kV	35 mA	25% on 4'	Grounded center	c Ⓢ US
TRG1225	230V	50Hz	2x6 kV	25 mA	25% on 4'	Grounded center	CE
TRG1230	230V	50Hz	2x6 kV	30 mA	33% on 3'	Grounded center	CE
TRG1230US	120V	60Hz	2x6 kV	30 mA	25% on 4'	Grounded center	c Ⓢ US

Applications | Applicazioni



Available certification | Certificazioni disponibili

